

**MEITZO**  
MACHINERY BV

WHEEL LOADER  
**XC918-EV**



*XCMG FOR YOUR SUCCESS*



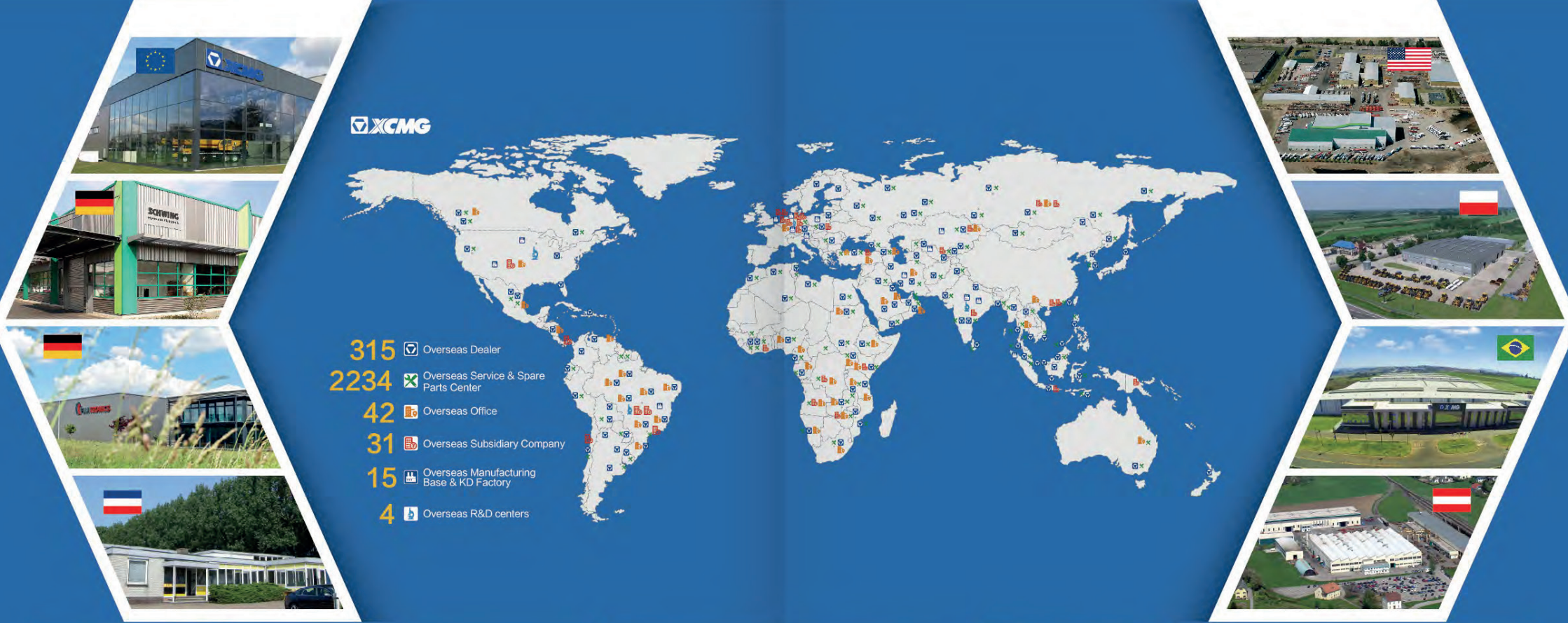

- 315** Overseas Dealer
- 2234** Overseas Service & Spare Parts Center
- 42** Overseas Office
- 31** Overseas Subsidiary Company
- 15** Overseas Manufacturing Base & KD Factory
- 4** Overseas R&D centers



## INTRODUCTION OF XCMG

XCMG, as a leading enterprise valued of 100 billion RMB, with the largest scale, the best technology level, the largest export volume, and high competitiveness and influence in China's construction machinery industry, has been occupying the first place in China's construction machinery industry for decades, and it now ranks the third in the world industry and the 395th among the world's top 500 brands.

The main products by XCMG consists of 16 categories of equipment such as hoisting machinery, excavation machinery, concrete machinery, mining machinery, earth-moving machinery and road machinery, etc., as well as three categories of key components such as hydraulic system, transmission system and electric control system. Among above-mentioned, hoisting machinery ranks first in the world, and package solution of road construction and maintenance machinery, piling machinery and concrete machinery are among the first-class bloc in the world.

XCMG has accumulated more than 8000 approved patents, including more than 1900 invention patents and more than 130 PCT international patents. Entities of R&D centers, manufacturing plants or KD factories are in operation in more than 10 countries such as Germany, the United States, Brazil and India, XCMG has also acquired three European enterprises including Schwing in Germany. The Brazil manufacturing plant, with an investment of 350 million dollars to build up factories on a bare ground, has become a model of economic cooperation between China and Brazil. At present, XCMG products are exported to 187 countries and regions, covering 97% of the countries along "The Belt and Road" area. In export business to 35 countries, XCMG's proportion ranks NO. 1, with a steady first place within Chinese industry in terms of annual export volume and overseas income.

## XCMG IN EUROPE

Since 1990s when XCMG was already a known brand within the industry in Europe, XCMG has been one of the major international manufacturers supplying products and service across the Continent. With its rapid development in recent years, XCMG is gradually building up an all-round network including: R&D department; local distribution, supply chain management and an integrated customer services and training center.

At present, XCMG has 3 subsidiaries in operation, with more than 100 multinational employees in Europe:

- ERC XCMG European research center GmbH
- EPC XCMG European purchasing center GmbH
- ESS XCMG European sales and services GmbH

XCMG is also holding a resource of more than 100 branches by local dealers throughout the Europe, generating a whole value chain that is serving the entire European market, including sales, service, financing, used equipment recycle, etc. We actively and continuously implement our globalization strategy. Our first-class international team has many years of professional experience and excellent cross-cultural management capability.

With a strong combination of expertise and practical experience in a multicultural context, we create real value and provide a high level of return on investment to our European customers.





## Product Overview

- ▶ The XCMG XC918-EV wheel loader, as the leading mini loader with environmental protection and the pioneer of sustainable development for machine-human-environment, featuring zero-emission with quiet, clean, comfortable, accessible, efficient, economical, flexible, and safe operation as well as the optional tools e.g. the pallet forks and grippers, etc. for multiple industrial applications including animal husbandry, agriculture, forestry and urban construction, etc.



## Product Advantages

### Performance Highlights

- ◆ Long battery life: No less than 3.5h for continuous heavy-loading operation, no less than 5.5h for continuous medium-loading operation, and no less than 8h for continuous light-loading operation.
- ◆ Flexibility: Central oscillation of 10° and articulated steering of  $\pm 40^\circ$  with reduced-tail design.
- ◆ Steering angle of 40° and a turning radius of no more than 3.7m for multiple conditions with complicated terrains.
- ◆ The maximum traction force of 50 kN and the maximum breakout force of 60.5 kN can meet the needs of heavy loading conditions.
- ◆ Quieter: Dual motor power intelligent matching technology, smooth transmission and lower noise.
- ◆ Cleanliness: Pure electric, zero-emission.
- ◆ Comfort: ROPS & FOPS full-view cab, integrated, F-N-R pilot control, 8-inch LCD screen, and Jack simulation technology to offer a luxurious experience.
- ◆ Convenience: Front-flipping engine hood and tilting driving cab with one-stop maintenance.
- ◆ High-efficiency: Compound control of speed and torque, intelligent pilot speed change, idling stop, and self-adaptive to working conditions.
- ◆ Economy: Compared with diesel loader, energy consumption cost is more than 50% energy saving, and maintenance costs such as air filter, machine filter and oil filter are eliminated.
- ◆ Safety: ROPS & FOPS driving cab with high-voltage open-circuit protection for easy maintenance. Three-level fail-safe protection design, high-voltage circuit breaker protection, safer maintenance.

## Advanced Technology

- ◆ Multiple technologies including efficient and reliable permanent magnet synchronous motor, intelligent compound control of speed and torque, idling stop, self-adaptive to working conditions will ensure low energy consumption during operation and assist the energy recovery and control system to minimize the energy consumption. The high-energy intensity LFP battery with a self-adaptive thermal management system will ensure proper operation and improve the battery life.

## Reliability

- ◆ The machine is using the CAE simulation analysis with a high safety factor. The front and rear frames are made of integrated structures for heavy-load with resistance and impact load under multiple working conditions. The LFP battery features a service life of more than 8 years and a life cycle of more than 4000 times. The enhanced drive axle features a high dynamic factor that applies to the heavy-loading conditions.



## Accessibility

- ◆ The front-flipping hood with a large opening angle and tilting cab will ensure the one-stop maintenance.



## Comfort

- ◆ The supercharged driving cab with panoramic vision is designed with a fastback hood and configured with multiple devices to offer a luxurious experience, including the accessible storage box and mobile phone box, F-N-R pilot control, 8-inch LCD screen, adjustable ergonomic seats and steering columns, Jack simulation technology, and the optimal aisle design.

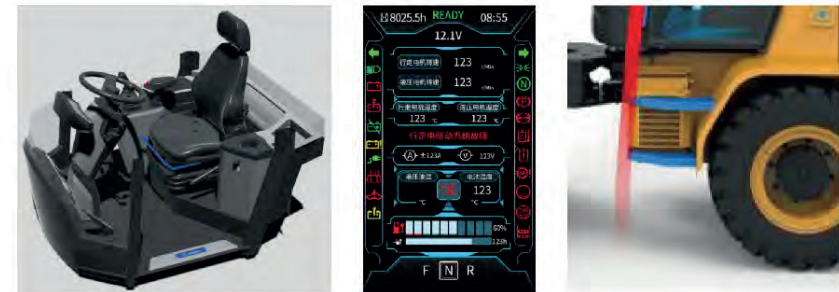

## Flexibility

- ◆ The machine is configured with a central articulated structure with 10° central oscillation, ±40° articulated steering, short-tail design, and limited turning radius. The fast-changing triple hydraulic system features the one-key change form multi-functionality.





## Advantages Of Electric Related Parts

- ◆ Reinforced drive axle, high dynamic load coefficient, more suitable for heavy load conditions.

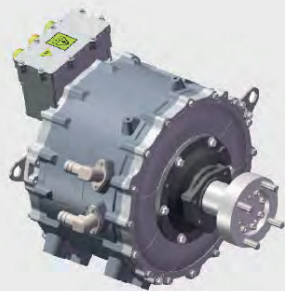
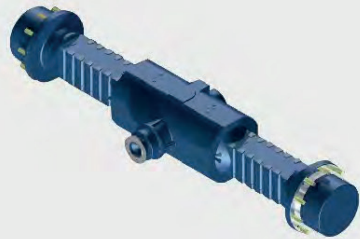

- ◆ The motor has low noise, high torque, fast response, and has a variety of torque and current protection functions, which are efficient, reliable and safe.

- ◆ The power battery has the advantages of good cycle performance, safety and reliability, long service life, no daily maintenance, etc., adaptive environmental thermal management, short charging time and strong endurance.



## Intelligent Management System

- ◆ XCMG's proprietary intelligent management system can grasp various operation data and maintenance status of the loader in real time through users' mobile phones, PADs, computers and other equipment, remind users to prepare for maintenance and repairs in advance, and prolong the service life of the equipment.
- ◆ Through data collection and analysis, users can achieve scientific and efficient management of loaders and operators, and improve the efficiency of equipment use.





# The Main Technical Parameters

## Overall dimensions

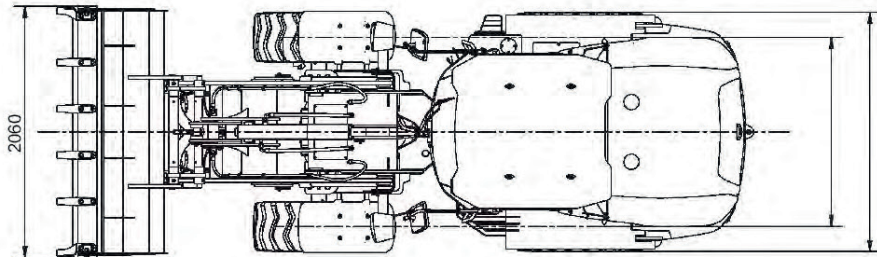
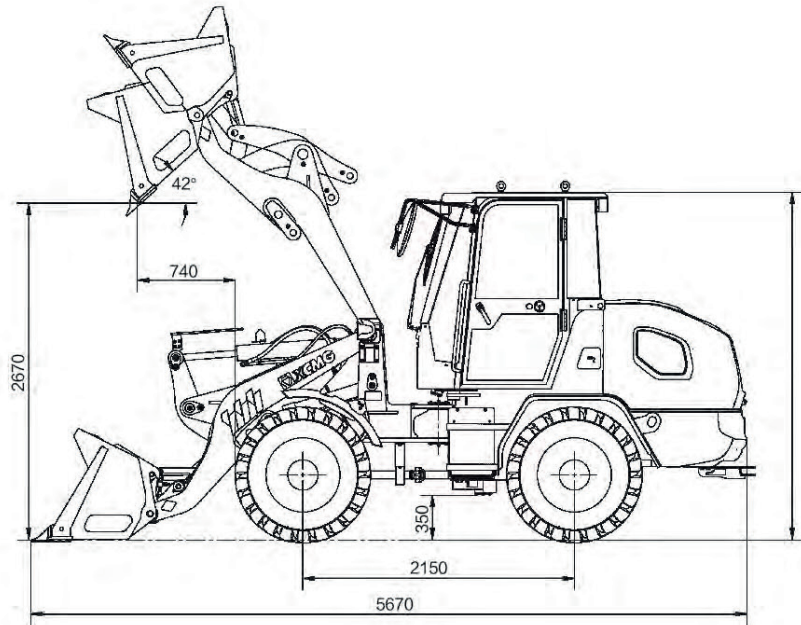

## Main specifications

Description	Specifications	Unit
Rated load	1800	kg
Bucket capacity	1.0	m <sup>3</sup>
Operating mass	6700	kg
Rated power of the motor	40/24	kW
Dumping height	2670	mm
Dumping range	740	mm
Minimum ground clearance	350	mm
Dumping angle	42	°
Wheelbase	2150	mm
Maximum breakout force	60.5	kN
Total cycle time	9.7	s
Minimum turning radius (tire center)	3.7	m
Tire specification	16/70-20	-
Steering angle	±40	°
Oscillation angle	10	°
Overall machine dimensions (LxW x H)	5670 x 2060 x 2750	mm
Traveling speed	0-20	km/h
Battery voltage	579.6	v
Battery capacity	173	Ah
Charging time	1 h (depending on the power of the charging pile)	h

# Optimum Services, XCMG Guaranteed



XCMG-approved attachments



Genuine parts



Extension of warranty



Financial solutions



Maintenance contract



Telematics

## Professional Integrated Complete Solutions

The XCMG group has built a strong reputation based on the quality, reliability, and durability of its construction machinery. What's more, XCMG has gradually established a service network to constantly provide its local integrated and highly efficient complete solutions for all customers.

## Full Range of Services Ready for you

In order to respond to your needs as fast as possible, XCMG experts are on their way to your job site from one of our facilities near you. A full range of services is available in order to reduce your total cost of ownership and increase your revenue.

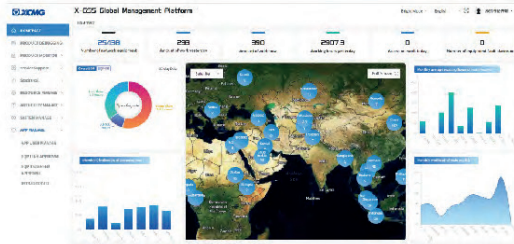

## XCMG Global Spare parts System

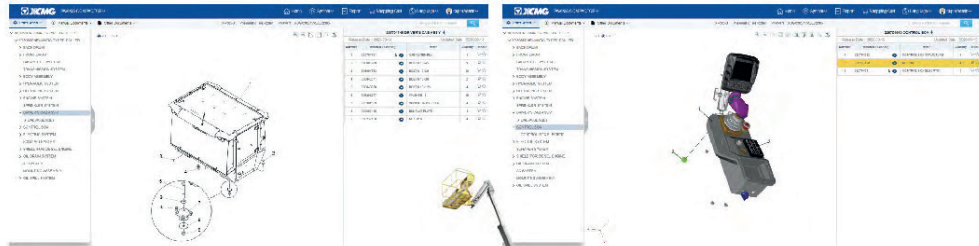

Mobile cranes



Excavators



Aerial work platforms



Wheel loaders



Road machinery





**MEIZO**  
MACHINERY BV



# METZO

MACHINERY BV

**METZO MACHINERY BV**

Lireweg 33

2153 PH Nieuw-Vennep



+31 252 675 654



[info@metzomachinery.nl](mailto:info@metzomachinery.nl)



[www.metzomachinery.nl](http://www.metzomachinery.nl)

